

Neptun HCS 1 Hygiene Station

IMPORTANT - READ FIRST

Only start up the machine after having read and understood these operating instructions. Should you need clarification, or have any questions, we are always available to help.

HEUTE® Hygiene Station Neptun HCS1 cleans and, at the same time, disinfects dirty soles of work shoes and boots. The separate hand cleaning station ensures effective hand disinfection. HEUTE® cleaning stations are built and tested in accordance with the latest safety regulations. The proper function and operational safety of the station can be guaranteed only, if the generally applicable safety precautions and station-specific safety information in these operating instructions are observed during use. The guarantee will lapse in case of damage caused by ignoring these operating instructions. The manufacturer shall not accept any liability for personal injury or damage to property arising from the aforesaid. In the event of problems, please immediately contact our service department.

Intended use

HEUTE® Hygiene Stations Neptun HCS1 are used to clean the outside surfaces of closed shoes and boots by means of electrically driven brushes as well as for non-contact hand disinfection in a separate station. Other use is not permitted! Only use the spare parts approved of by the manufacturer of the machines. Operation is permissible only in closed rooms observing the regulations stipulated in the chapter "Safety instructions".

Operation in explosive environments is not permitted.

Foreseeable misuse

Basically, HEUTE® Neptun HCS 1 Hygiene Station must not be used for:

- Cleaning and care of human body parts and objects that are no part of footwear.
- Use as hand-held device to process surfaces.
- Use with the addition of caustic fluids

Safety instructions



Read these operating instructions precisely and follow the instructions for starting up and use.

The machine must not be changed or modified because this may lead to risks, such as short circuit, electric shock or fire. Maintenance and repair must be carried out exclusively by persons authorised for the purpose, using original parts only. The use of non-original spare parts or the unauthorised modifications of the machine will result in cancellation of the declaration of conformity issued by the manufacturer/distributor and **CE** sign as well.

Use the machine in closed rooms only.

Operation is only permissible at ambient temperatures between 0 deg. C and 40 deg. C.

The machine is not suitable for uninterrupted continuous operation. By all means consider the values for short-time operation (STO) mentioned on page 15 (Technical data).



Do not continue using the machine when the cleaning brushes are worn. This may damage the shoes. The brushes must be replaced by a qualified person.



The design complies with the protection class IP55 specification. The voltage supply is three-phase 400 V + grounding - power: 0.80 kW. Observe the specific data provided on the factory label!



During use, the motor may heat up to temperatures up to 90 deg. C. Do not touch the hot motor without safety gloves.



Use by children, in particular when unattended, must be ruled out. Make sure that any contact between pets and the machine is ruled out.

Please observe without fail that whilst the roller brushes are used, no shoelaces, tongues and straps on the sides of the shoes/boots will touch the ground. They can be caught by the roller brushes, which could cause injuries and damage of the footwear.



As a matter of principle, disconnect the mains plug prior to cleaning, service and repair work. Do not continue using the machine when the machine or the switch cabinet with wiring, the water supply or discharge are damaged.



Ensure that the machine is installed at ground level.

Enter and use the machine only with closed footwear appropriate for wet cleaning.

Danger of slipping - observe slippery floor coverings in front of and next to the machine caused by splashing water.

Do not touch roller brushes, whilst the machine is in operation.

Never drink the fluid from the machine or optional containers for detergent / disinfectant.

Excessive contact pressure during use of the brushes can lead to damage of shoes//boots!

Stop using the machine, if the brushes do not rotate freely and hazardous foreign objects affect the function.

The user of the equipment is responsible for the selection of the appropriate detergents and disinfectants and their compatibility, particularly the ones for hand disinfection.

The user is responsible for any personal injury and damage to property that arise due to improper use, faulty machine connection and/or operating errors.

When installed in commercial facilities, comply with the industrial safety regulation applicable on site as well as the accident prevention regulations issued by the professional associations for electrical systems and operating equipment.

Welcome

Dear customer, we would like to thank you for purchasing one of our HEUTE® Neptun HCS 1 Hygiene stations. You have purchased a quality product, which – if used properly– will deliver clean results for many years.

These operating instructions are a part of the machine, which contains important information on commissioning, operation and maintenance. Please keep these operating instructions for future reference!

Scope of delivery

Neptun HCS 1 Hygiene station with integrated sole cleaning and hand disinfection stations, operating instructions.

Declaration of conformity

The manufacturer herewith confirms that the machines of type Neptun HCS 1 described in the following comply with the directives listed below:

- machinery directive (2006/42/EC)

Authorized representative Steffen Moersch,
same address as manufacturer.

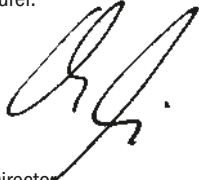

Christian Löwe, Managing Director
HEUTE Maschinenfabrik GmbH & Co. KG

Environmental protection

Disposal of the transport packaging

The packaging materials of your new machine are environmentally friendly and recyclable. Please help by disposing the packaging in an environmentally friendly manner. The packaging must not be given to children to play with. There is a risk of suffocation caused by the cardboard packaging and plastic films.

Disposal of the product

Old devices that are no longer in use are no worthless waste. Valuable raw materials can be recovered by environmentally friendly disposal. Please inform yourself about the current disposal methods by contacting the responsible person in your company or your local authority.

Contents

| | |
|---|-----------|
| Important - read first | 2 |
| Intended use | 2 |
| Foreseeable misuse | 2 |
| Safety instructions | 2 |
| Welcome | 3 |
| Scope of delivery | 3 |
| Declaration of conformity | 3 |
| Environmental protection | 3 |
| Survey | 4 |
| Installation and commissioning | 6 |
| General information | 6 |
| Transport and installation | 6 |
| Precautions when commissioning | 6 |
| Water connection | 6 |
| Wastewater connection | 6 |
| Electric connection | 6 |
| Operation | 7 |
| Cleaning principle | 7 |
| Use of the sole cleaning function | 7 |
| Adjustment of water quantity - access | 7 |
| Adjustment of water quantity | 7 |
| Hand disinfection | 8 |
| System options - national language | 8 |
| System options - runtime of the brushes for sole cleaning | 8 |
| System options - medium quantity for hand disinfection | 8 |
| Prolonged non-use | 8 |
| Service and maintenance | 9 |
| Control | 9 |
| Cleaning | 9 |
| Maintenance | 9 |
| Recommended service intervals | 9 |
| Change of roller brushes | 9 |
| Cleaning of surfaces | 10 |
| Cleaning and access to the coarse dirt screen | 10 |
| Cleaning of brushes | 10 |
| Disassembly of the brush shaft | 10 |
| Gear motor - access | 11 |
| Dosing system for sole cleaning - access | 11 |
| Dosing system for sole cleaning | 11 |
| Dosing system for sole cleaning - activation | 12 |
| Dosing system for sole cleaning - flushing | 12 |
| Dosing system for hand cleaning - access | 13 |
| Dosing system for hand cleaning - setting | 13 |
| Dosing system for hand cleaning - activation | 13 |
| Dosing system for hand cleaning - flushing | 13 |
| Trouble shooting | 14 |
| Technical data | 15 |
| Wiring diagrams | 16 |
| Part drawings | 19 |

Installation and commissioning

General information

Please observe, implicitly, the following instructions on the protection of the stainless steel housing of the sole cleaning equipment during storage, before installation and use.

- Protect the machine from external environmental impacts, such as rain, sunshine and frost. The machine is made for indoor use only.
- The stainless steel surface of the machine must not get in touch with other steel grades so that no contact corrosion occurs (e.g. carbon steels, steel chips, tools used for steel machining).

Transport and installation

Due to the weight and bulky dimensions, the machine is recommended to be unpacked and transported to the site of installation by 4 persons making use of suitable transport equipment - machine weight approx. 213 kg.

Use the machine indoors only. When selecting the site of installation required floor area 1,619 x 935 mm - take the water inlet and outlet as well as the power supply into account (see chapter **Installation and commissioning**). The machine must be installed on horizontal and anti-slip ground. In order to ensure stability of the machine level out any uneven floor areas by adjusting the feet with a suitable spirit level.

Precautions when commissioning



Never remove or block the interlocking/contact switches on the housing, which are activated with closed/lowered grating. If, when the machine running, the grating opens, the switches automatically cut-off the media supplies (water, power) and stop the brushes from rotating.



When installing the water inlet, there is risk of contamination, which may obstruct pipes, nozzles and dosing unit as well as damage the solenoid valve. Make sure that the machine is free of metallic and plastic residues before connecting the machine to the electric circuit.

Water connection

- Inlet, diameter ½"
- Recommended operating pressure: 3 bar
- Maximum operating pressure: 6 bar
- Operating temperature between 30 deg. C and 50 deg. C (water temperature above 60 deg. C damages the brushes).
- Water flow rate: approx. 7 l/min at 3 bar (setting valve on the unit).

The machine leaves the works without being equipped with an upstream check valve and water filter. If necessary, install a check valve and water filter upstream.

The water quantity requested for cleaning can be individually adjusted by a screw top - see chapter **Operation** > *Setting of the water quantity*

Locate the canisters for sole cleaning (Fig. 1) and hand disinfection (Fig. 2) (both items are not included in the scope of delivery) at a suitable place according to the length of the supply line. For the supply of the respective medium see chapter **Service and maintenance** > *Dosing system for sole cleaning - activation* and *Dosing system for hand cleaning - activation*.

Fig. 1



Fig. 2



Wastewater connection

- Outlet with a diam. 42 mm with threaded end 1 ½" (Fig. 3)

Fig. 3



Electric connection

- three-phase 400 V + grounding - power: 0.80 kW (Fig. 4).
- Connect to the terminal in the switch cabinet (see **Wiring diagrams** > *Configuration of the terminal strips I und II*) below).



Make sure that the required power supply of the machine corresponds to the voltage rendered available in your country.



The power supply of the machine must be electrically protected from indirect contacts:

- High-sensitive Residual Current operated protective Device (RCD), max. 30 mA.
- This protection must be provided by the in-plant installation and is not included in the scope of delivery of the machine.
- For starting up set the main switch to position "I" (Fig. 5).
- The machine leaves the works with an emergency stop switch (Fig. 6). In case of emergency or danger press the switch to immediately stop the machine.
- Switch on and test the direction of rotation of the brushes.



Operation

Cleaning principle

- Cleaning of the sole profile of shoes and boots by horizontal roller brushes (Fig. 7).
- Supply of water and detergent; dosage by mixture in the dosing system.



Use of the sole cleaning function

Sole cleaning is activated when passing through the machine (possible from both sides) by releasing an opto-electrical signal (light barrier) (Fig. 8) and initiates the following operations:

- Rotation of the roller brushes (gear motor driven).
- Opening a solenoid valve with dosing system and supply of water as well as detergent onto the rotating roller brushes.

The operation stops when the light barrier is de-excited.

Basically, the machine can be passed through from either side, since the optical sensors were built-in on each side. The mechanical access block and optical release of the turnstile, however, are enabled from the brush side of the equipment only. The release of the turnstile (Fig. 12) is displayed visually by the changing indicator light (from red to green, see Figs. 12 - 13). Entering the equipment from the opposite side, the turnstile is not blocked and the optical release is active.



Adjustment of water quantity - access

The setting handle for adjusting the water quantity is accessible on the face below the checker plate. Changeover the bow lock and lift off the checker plate - no tool required (Fig. 9).

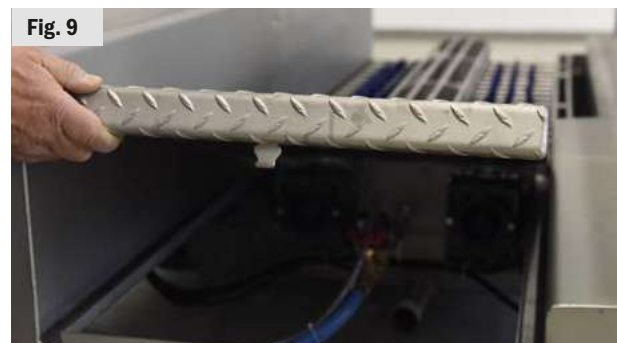

Adjustment of water quantity

The water quantity requested for cleaning can be individually adjusted by valve (Fig. 10). Water flow approx. 7 litres per minute.



Hand disinfection

The contactless hand disinfection is enabled by activating the two infrared sensors by inserting both hands with the palms pointing to top into the hand washing station (Fig. 11). The medium is sprayed onto the palms according to the programmed setting. Then retract both hands and rub the medium uniformly on the palm and exterior hand surfaces. The built-in turnstile (Fig. 12) releases the access only when the cleaning of the hands has been completed. The release is optically indicated by changing from red to green display on the hand station (Fig. 13).

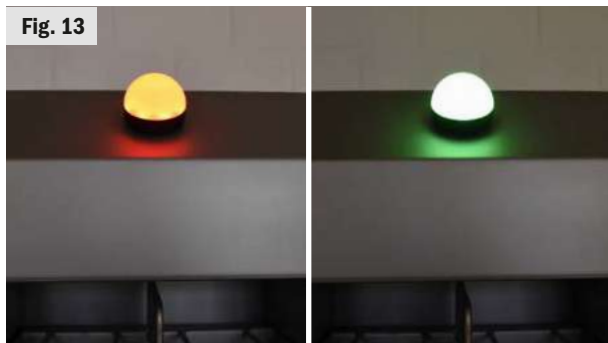

System options – access and options

In order to change the system settings - see below - open the switch cabinet door with the available special key (including in the delivery) (Fig. 14). After changing the system setting correspondingly, close the door properly.



System options – national language

Press the two buttons (A) + (B) at the same time for minimum of 5 seconds until the display changes over to the language indication mode. Use the two buttons +/- to toggle between English and French displays. Display value 1 = English, display value 0 = French. Then press the green OK button to save the selection and leave the menu with the ESC button (Fig. 15).

System options – runtime of the brushes for sole cleaning function

Ex works, the runtime of the brushes is set to 10 seconds after contact with the light barrier. In order to change this default value, press button (A) to get to the "sole washer" menu. Select as desired the runtime of the brushes with the +/- buttons. After specifying the value, leave the menu with the ESC button. The value is saved and does not need to be confirmed (Fig. 15).

System options - medium quantity for hand disinfection

The quantity of the medium output through the two nozzles is approx. 2 ml per second. Ex works, the value is set to 0.5 second = 1 ml. The value is freely adjustable in 0.1 second increments. For changing, press the button (A) twice to get to the menu. The second factor is adjustable as wanted with the +/- buttons. After specifying the value, leave the menu with the ESC button. The value is saved and does not need to be confirmed (Fig. 15).

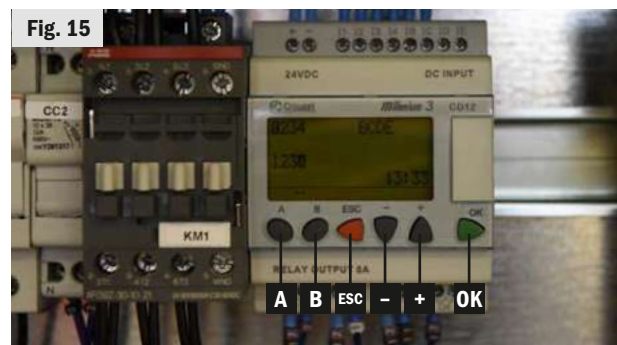

Prolonged non-use

If the machine is supposed to be out of operation over a longer period of time (e.g. company holidays), please flush the dosing units as preventive measure to avoid deposits or line clogging in the dosing systems.

The instructions on flushing the dosing systems for sole and hand cleaning are described in chapter **Service and maintenance** > *Dosing system Sole cleaning – Flushing* and *Dosing system Hand cleaning – Flushing*.

Service and maintenance

Servicing and repairs on the machine are to be carried out by trained qualified personnel only. In order to ensure optimal function of the sole cleaning machine, the system has to be inspected, cleaned and serviced in regularly intervals. HEUTE® cleaning machines are low-maintenance and reliable. However, there are some components, which will wear after a long period of service and/or will reduce the cleaning quality.



Unplug the power supply prior to all interventions in the station.



Before any intervention on the station, stop the water supply.



If the step-on grating has been unintentionally opened, the rotation of the roller brushes automatically stops and the solenoid valve of the water supply is shut-off.

Control

The machine should be checked for correct function regularly. While doing so, inspect whether components are damaged or worn and whether the machine is able ensure the required cleaning effect. No foreign matter is allowed to be within the rotary area of the roller brushes.

Cleaning

The cleaning intervals of the machine depend on the in-plant operating conditions. With increasing dirt, shorten the cleaning intervals. With decreasing dirt, extend the cleaning intervals accordingly. Cleaning also includes scheduled cleaning of both the dosing systems. The composition of the applied detergents and disinfectants has to comply with the in-plant regulations for hygiene and cleanness.

Maintenance

The Neptun HCS1 Hygiene Station is considered to be very low-maintenance and reliable. However, there are some components, which will wear after a long period of service and will reduce the cleaning quality - e.g. brushes.

Brushes, the bristles of which, for example, have snapped off or got too soft to be able removing dirt in active manner, point to excessive wear.

Suitable spare parts can be purchased from the specialist dealer or manufacturer.

Instructions on replacement of wearing parts are described below in the chapter **Service and maintenance**.

Recommended service intervals

The values specified in the table below are our empirical values. In this regard, however, the real applications play the decisive part (kind of contamination, service period, et cetera). Thus, refer to own experience when adapting the intervals.

| Service | Interval |
|--|--|
| Control | 1 x / week |
| Cleaning of surfaces | 1 x / week |
| Cleaning of coarse dirt screen | 1 x / week |
| Cleaning of brushes | 1 x / month |
| Cleaning of the dosing units - Sole cleaning - Hand cleaning | 1 x / month or with medium renewal, as basic rule. |
| Change of roller brushes | every 5-7 years, or when worn |

Change of roller brushes

1. Lift up the grating (locking function when open) to get access to the two roller brushes and to activate the switching-off function of the machine. The roller brushes can be removed without special tools (by two persons, if necessary) (Fig. 16).
2. Horizontal roller brushes: Pull the front side up (Fig. 17). The roller brushes are driven by a cross pin placed on the gear motor side.
3. When re-inserting the roller brushes make sure that the cross pin is positioned correctly and the brush fits properly.

Fig. 16



Fig. 17



Cleaning of surfaces

The micro-blast stainless steel surface is made of stainless steel type 304.

During the cleaning work, the following has to be prevented, and cleaning has to be carried out always by thoroughly flushing with clear water:

- Contact with carbon steel
- Usage of steel sponge, grinding powder
- Application of chlorine products and bleaching agents

Cleaning and access to the coarse dirt screen

Remove the roller brush first – cf. chapter **Service and maintenance** > *Change of the roller brush*

Remove the coarse dirt screen (Fig. 18).

Assemble in reversed order.

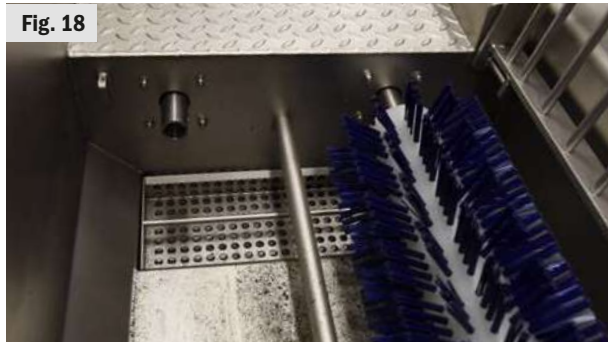

Cleaning of brushes

Clean and disinfect the built-in Nylon brushes with a sufficiently large volume of depressurised water or soak in suitable detergent. Do not use detergents based on chlorine bleaching, in no case. Never apply any high-pressure cleaning technique. Brushes, the bristles of which, for example, have snapped off or got too soft to be able to remove dirt in active manner, point to excessive wear.

Disassembly of the brush shaft

1. Remove the roller brush (cf. chapter **Service and maintenance** > *Change of the roller brush*).
2. Remove the socket-head screw on the front longitudinal side of the brush body with suitable tool (Fig. 19).
3. Remove snap ring located at the face of the brush body with suitable tool, and subsequently extract the spacer ring (Fig. 20).
4. Now, separate the brush body from the shaft (Fig. 21).
5. When assembling, fit the pin in that place provided in the brush hub, tighten the grub screw, attach the ring (diam. 30 mm) and mount the snap ring.

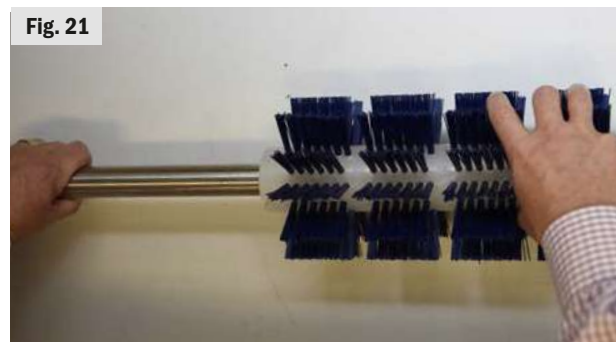
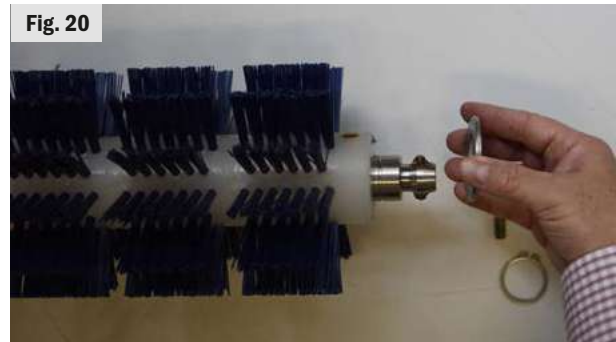

Gear motor – access

The built-in gear motors are 100 percent free of maintenance (Fig. 22). For access to the two motors take the actions explained in the following description **Service and maintenance** > *Dosing system Sole cleaning – access*.



Dosing system for sole cleaning – access

Remove the bow lock by folding – no tool required – and remove the checker plate to the top (Fig. 23). The mixing system is located between the two gear motors (Fig. 24).

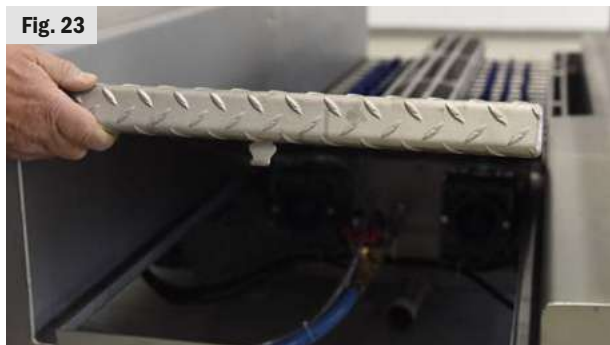

Dosing system for sole cleaning

The dosing system mixes water and detergent/disinfectant at a specified ratio. This ratio is determined by the respectively installed nozzle. In order to ensure optimal function, use a product that has the same viscosity as water. Avoid the use of crystallised detergent/disinfectant.

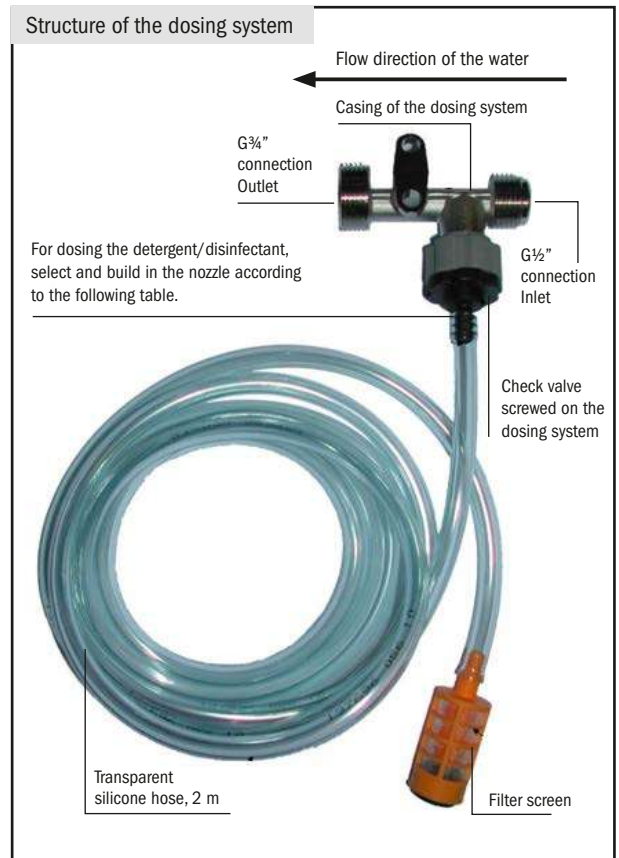

The detergent/disinfectant is dosed by nozzles of different sizes – supplied with the machine (Fig. 25). To obtain the desired concentration, select the appropriate nozzle (see the table below). The data in the table below are to be considered as guideline to facilitate the selection of the appropriate nozzle for the requested concentration. To adjust the dosing as precisely as possible, carry out some tests. The transparent nozzle is a stopper.



| Nozzle colour | Admixture of detergent/disinfectant |
|---------------|-------------------------------------|
| without | 13,80 % |
| grey | 13,50 % |
| black | 12,50 % |
| beige | 10,50 % |
| red | 7,90 % |
| white | 5,80 % |
| blue | 4,80 % |
| light brown | 3,20 % |
| green | 2,60 % |
| orange | 1,90 % |
| yellow | 1,50 % |
| dark brown | 1,20 % |
| turquoise | 0,65 % |
| violet | 0,50 % |
| pink | 0,20 % |
| transparent | 0,00 % (used as stopper) |

1. View the structure of the dosing system – cf. chapter **Service and maintenance** > *Dosing*> *Structure of the dosing system*.
2. For that purpose, remove the transparent silicone hose fixed on the check valve by rotary movement.
3. Fit the previously selected nozzle with the narrow end piece on to the check valve.
4. Then attach the transparent silicone hose to the check valve. Make sure that the transparent silicone hose is completely fixed on to the check valve and not kinked.

Dosing system for sole cleaning – activation

The detergent/disinfectant is activated by water supply through the system.

1. During commissioning, submerge the hose end including the attached screen into the detergent container/canister (Fig. 26) – container not included in the scope of delivery. The detergent/disinfectant must not contain chlorine or bleaching ingredients because they could damage the stainless steel surface, brushes and other components.
2. Switch on the machine by activating the light barrier until the medium to be dosed has reached the level of the mixing tap system (Fig. 27). To achieve a perfect function and mixture, use detergents/disinfectants having the same viscosity as water (water = viscosity of 1). Media of higher viscosity (semifluid) may cause functional problems.

Fig. 26



Fig. 27



Dosing system for sole cleaning – flushing

We recommend to flush the system for the detergent / disinfectant on a regular basis. As basic rule, however, whenever changing the detergent / disinfectant canister or with every maintenance work, clean the station. For that purpose, submerge the silicone hose with attached dirt screen into a canister filled with clear water and run the machine for 20-30 seconds.

Deposition and foreign matter could cause damage to the system. Thus, if the machine has not been used for a longer time, check that the silicone hose and dirt screen attachment (on the silicone hose) are free of depositions. If required, flush the dosing system with clear tap water.

Dosing system for hand cleaning – access

See chapter **Service and maintenance** > System options – Access and options.

Dosing system for hand cleaning – setting

The setting options (media quantity) can be adjusted as desired. Access through the door of the switch cabinet - see chapter **Service and maintenance** > System options - Medium quantity for hand disinfection.

Dosing system for hand cleaning – activation

The detergent / disinfectant is activated whenever the hygiene hand station is used (Fig. 28).

During first commissioning, handle the medium for hand disinfection in the same way as the dosing system for sole cleaning – see chapter **Service and maintenance** > Dosing system for sole cleaning – activation. Exciting the two hand sensors, the medium is fed from the canister - see chapter **Service and maintenance** > Dosing system for sole cleaning - activation. The supply of the disinfectant can be accelerated pressing the separate button (Fig. 29).

Fig. 28



Dosing system for hand cleaning – flushing

We recommend to flush the system for the detergent / disinfectant on a regular basis. As basic rule, however, clean the station whenever changing the detergent / disinfectant canister or with every maintenance work. For that purpose, submerge the silicone hose with attached dirt screen into a canister filled with clear tap water and press the button (Fig. 29) for 20-30 seconds.

Deposition and foreign matter could cause damage to the system. Thus, if the machine has not been used for a longer time, check the sole cleaning machine before use that the silicone hose is free of depositions. If required, flush the dosing system with clear tap water.

Fig. 29



Trouble shooting by qualified personnel

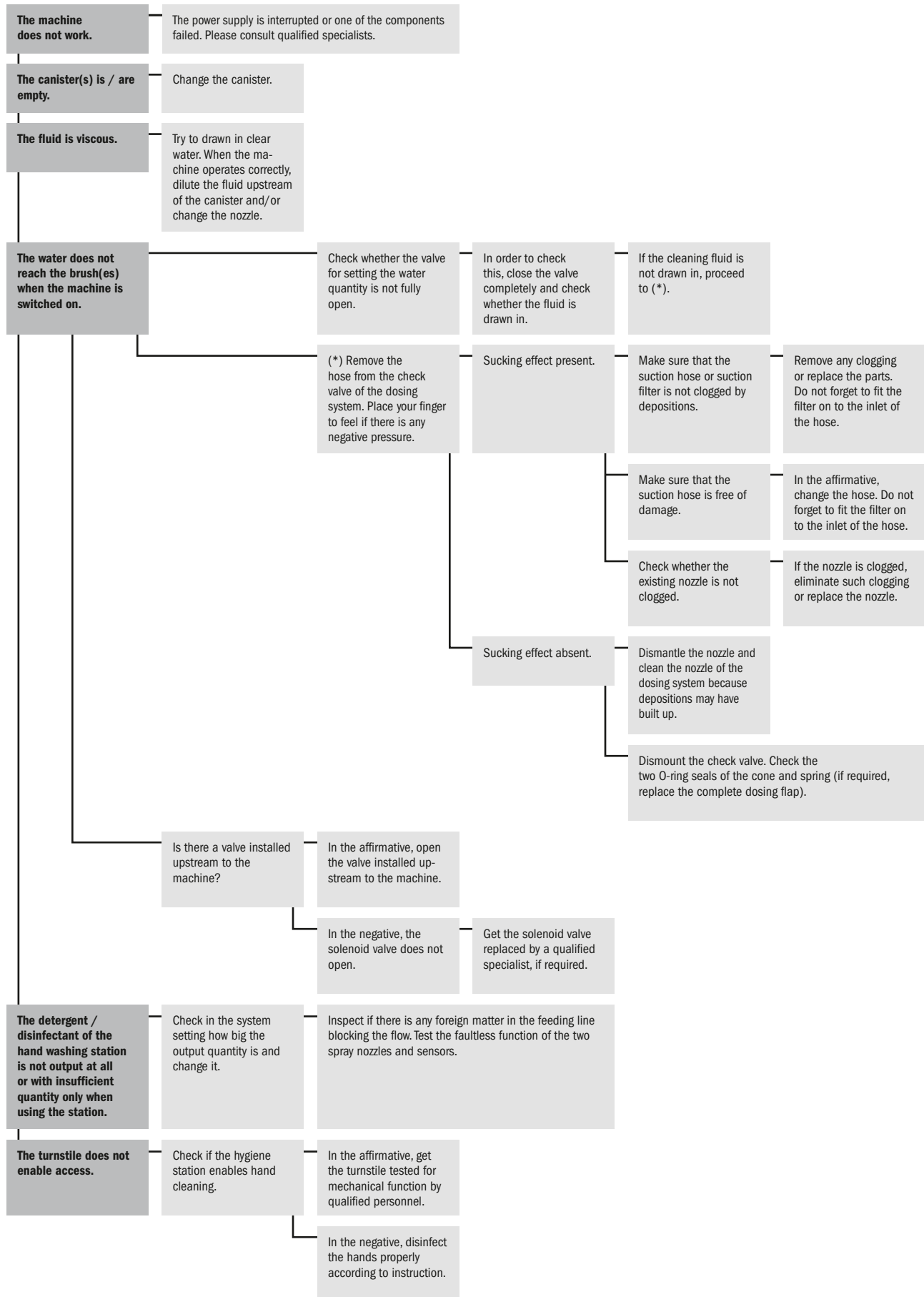

Trouble shooting by qualified personnel

? The machine operates without water.

! The water supply is not opened or is interrupted.

✓ Check the water supply.

? The runtime of the brushes is too slow / too long.

! Incorrect value pre-set.

✓ Setting - check brush runtime (see chapter **Operation** > *System options - runtime of the brushes for sole cleaning function*)

? The machine does not drain the wastewater.

! Water draining port is clogged.

✓ Check the water outlet - remove any clogging, if required.

? The motor is blocked or runs rough.

! Foreign matter is inside running parts.

✓ Immediately disconnect the machine from the power supply. Inspect the machine and roller brushes for foreign matter (turning the roller brushes by hand), and remove such matter.

? The machine is very loud during the cleaning process.

! Foreign matter is inside running parts.

✓ Immediately disconnect the machine from the power supply. Inspect the machine and roller brushes for foreign matter (turning the roller brushes by hand), and remove such matter.

or

! Inspect the roller brushes for correct fit.

Technical data

| | |
|-----------------------------|------------------------------------|
| Dimensions: | 1,619 x 910 x 1,662 mm (B x T x H) |
| Weight: | 213 kg |
| Connected values: | three-phase 400 V + grounding |
| Power: | 0.80 kW |
| Protection class: | IP55 |
| Short-time operation (STO): | 8 min |
| Airborne noise emission: | less than 80 dB(A) |

Neptun HCS 1 circuit diagrams

Circuit diagram (I)

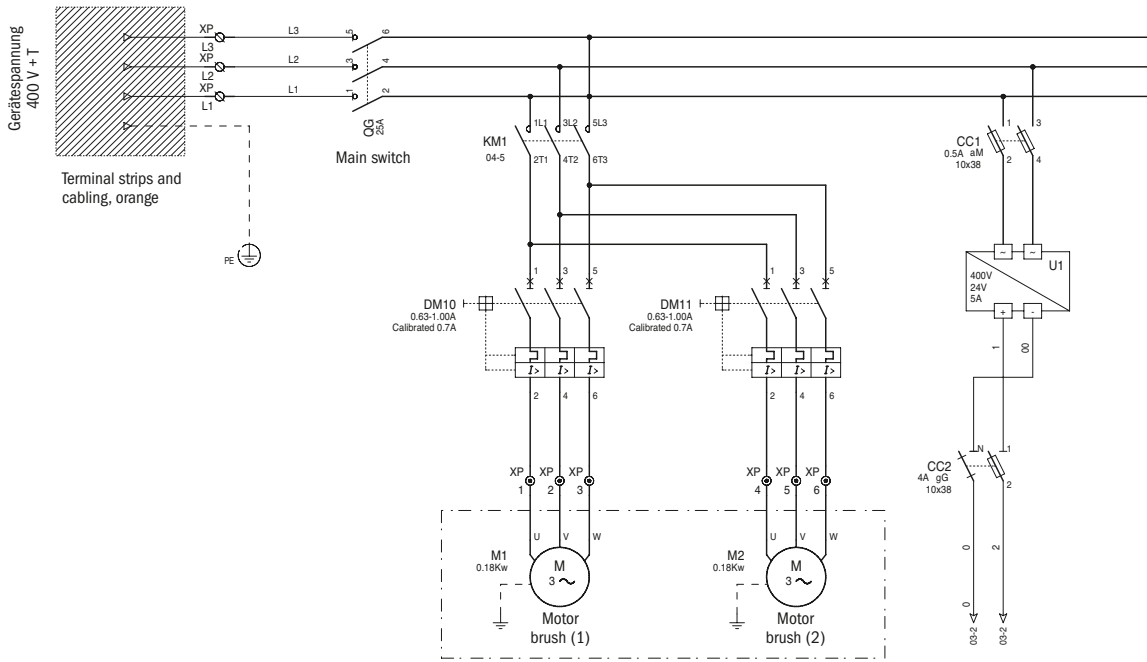

Circuit diagram (II)

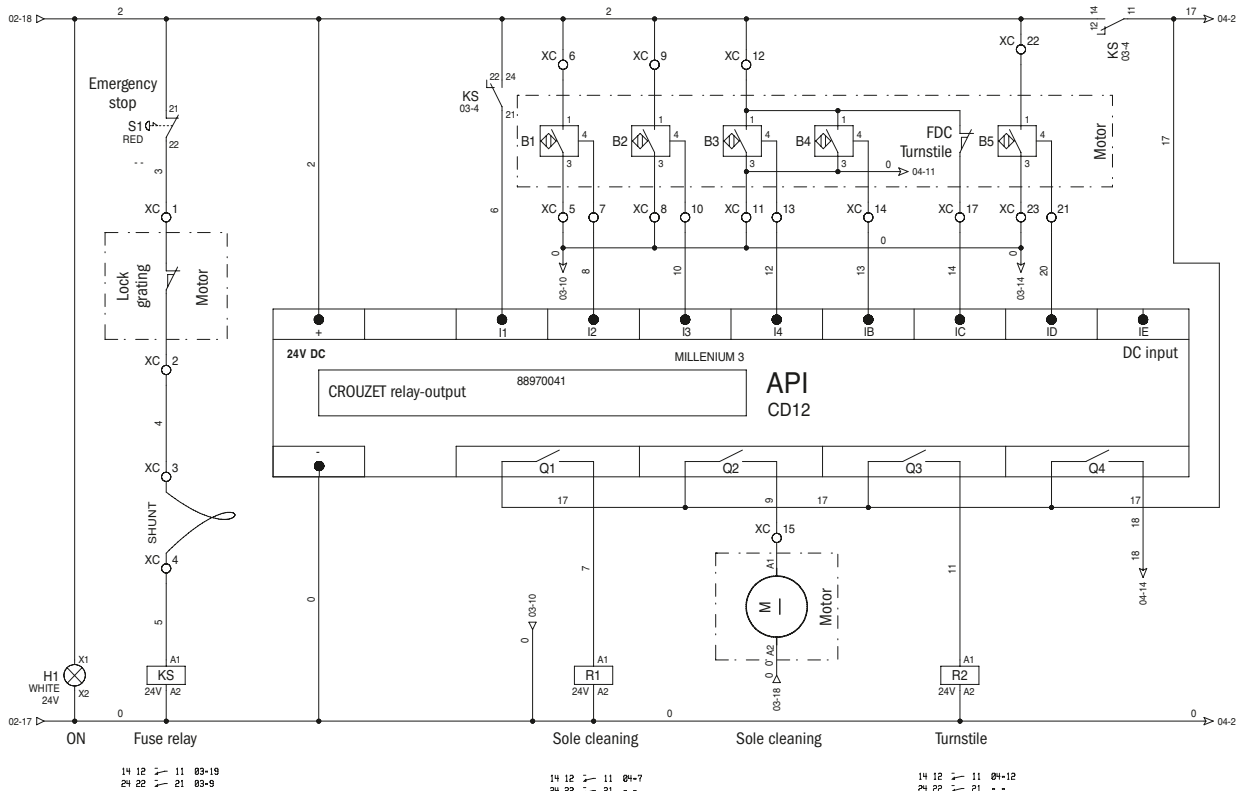

Circuit diagram (III)

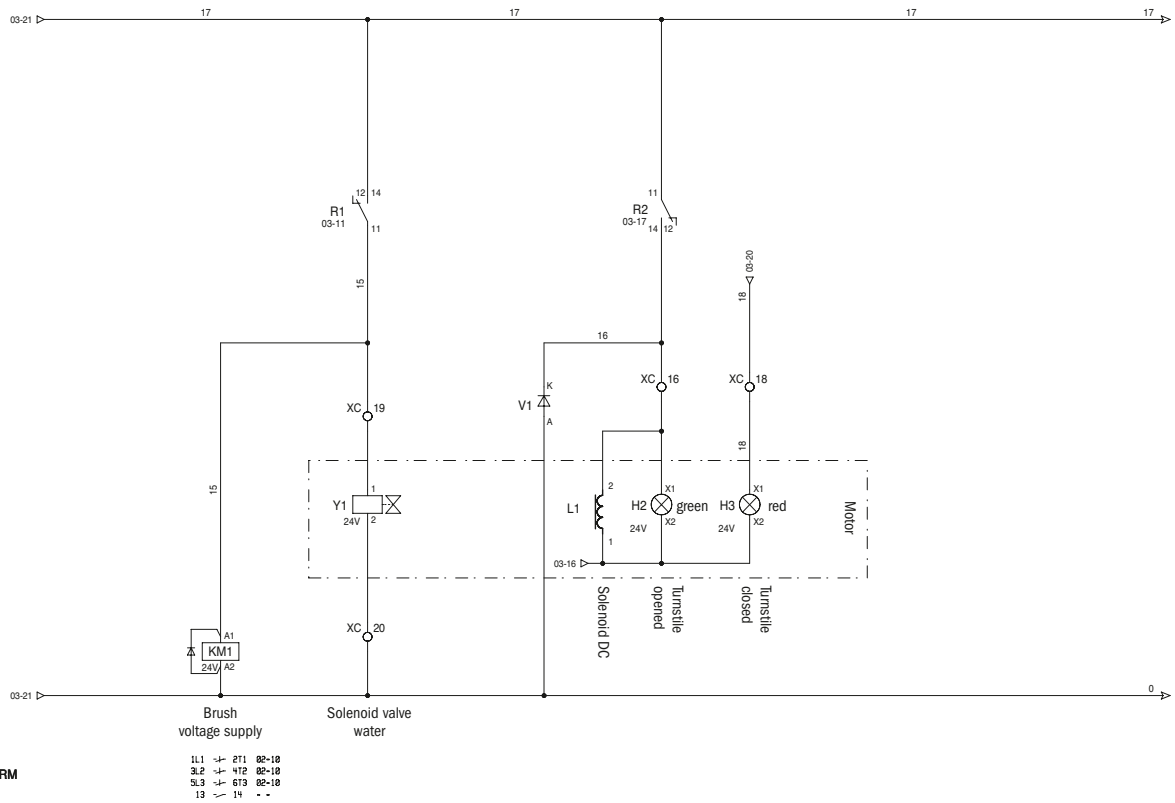

Circuit diagram (IV)

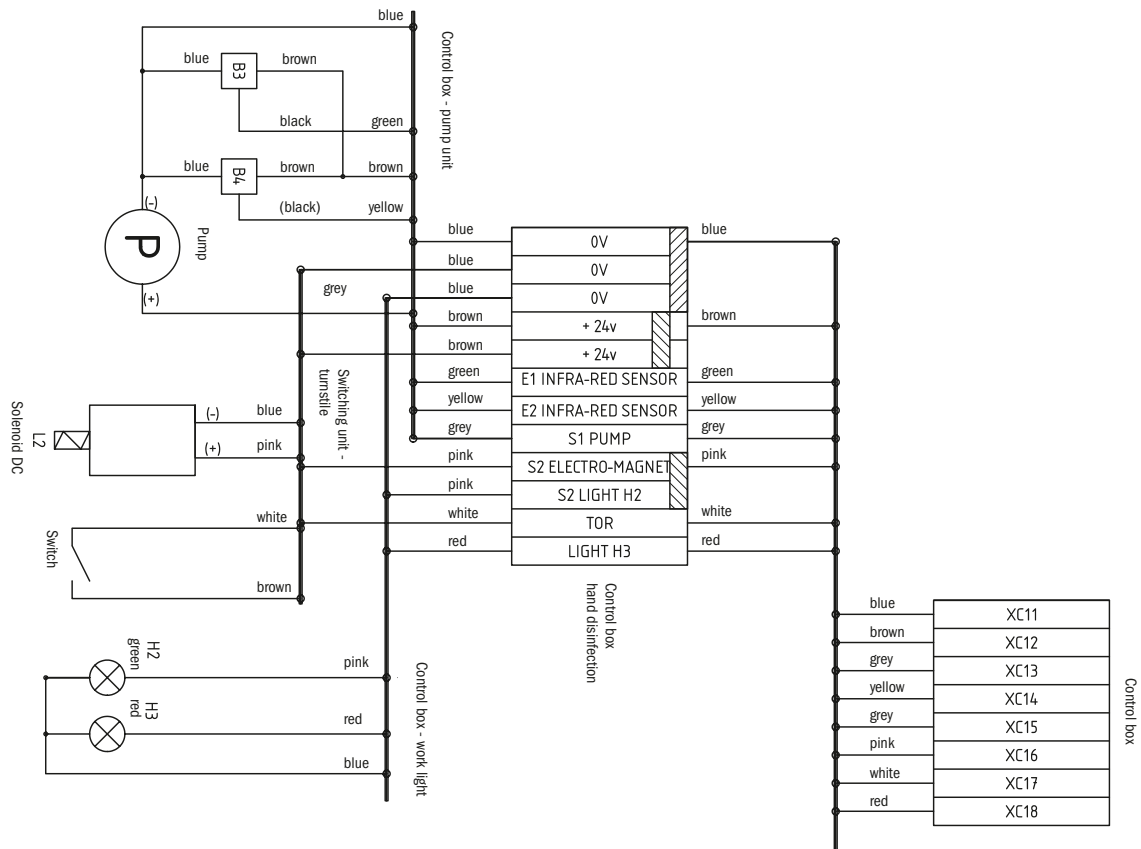

Neptun HCS 1 circuit diagrams

Assignment of the terminal strips (I)

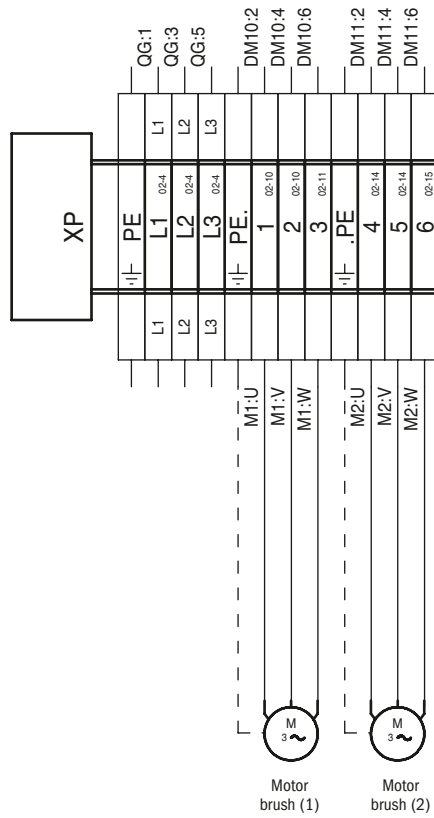

Assignment of the terminal strips (II)

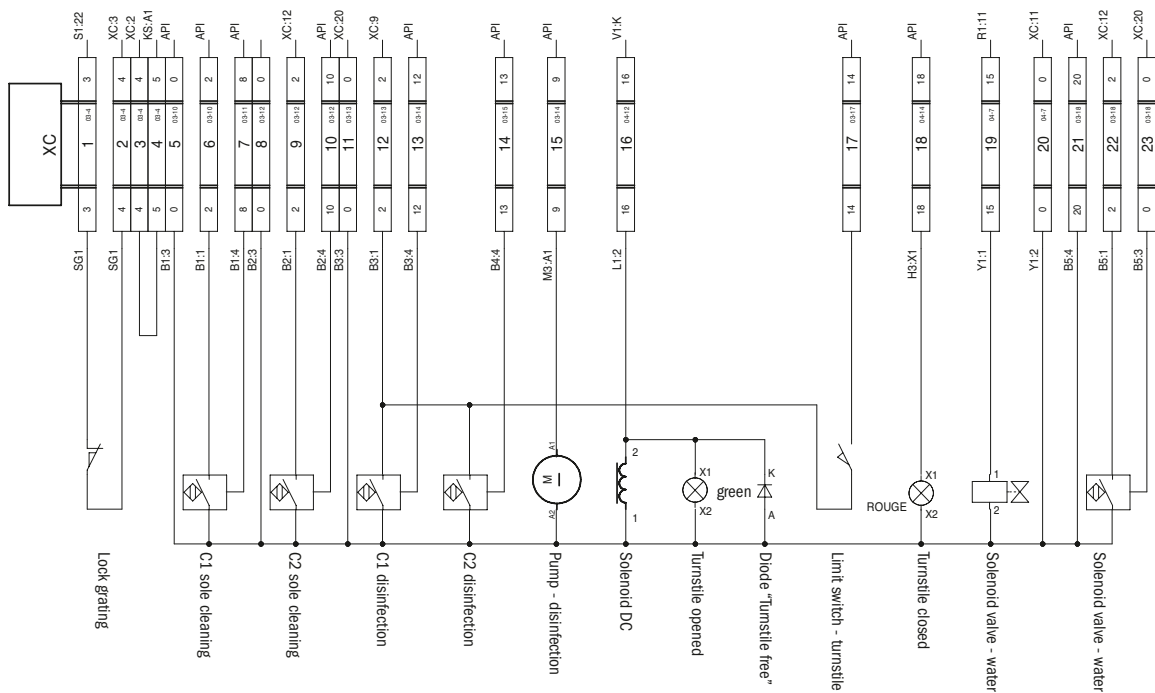

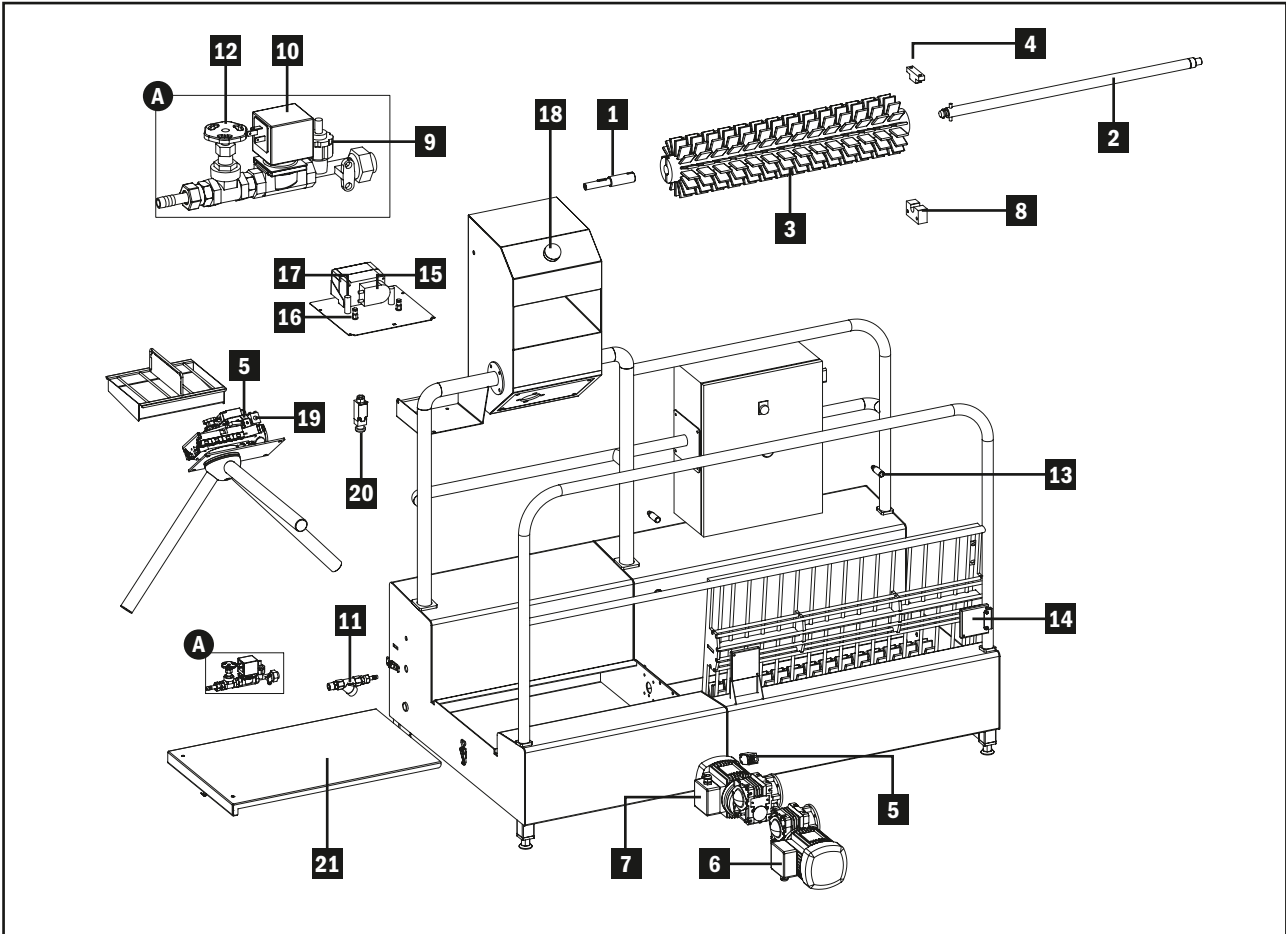

| Item | Item No. |
|--|----------|
| 1 Coupling - stainless steel | 06800401 |
| 2 Shaft of the roller brush, diam. 180 x 800 mm, stainless steel 304 | 06800402 |
| 3 Roller brush, diam. 180 mm, length 800 mm - PBT-blue | 06800403 |
| 4 Thrust bearing | 06800404 |
| 5 Switch AP3T13Z11 | 06800405 |
| 6 Motor P=037 kW-M50C-D1 | 06800406 |
| 7 Motor P=037 kW-M50C-D1 | 06800407 |
| 8 Bearing | 06800408 |
| 9 Dosing system - dosage meter 3.5 | 06800409 |
| 10 Solenoid valve 24Vcc-NF-½" | 06800410 |
| 11 Filter | 06800411 |
| 12 Valve ½" | 06800412 |
| 13 Light barrier OGH200 | 06800413 |
| 14 Reflector for light barrier OGH200 | 06800414 |
| 15 Pump unit M500 24VDC | 06800415 |
| 16 Nozzle PPH B1/BHH-PP1.3 | 06800416 |
| 17 Sensor OGH200 | 06800417 |
| 18 Light unit | 06800418 |
| 19 Solenoid 24 VDC | 06800419 |
| 20 Button - hand cleaning | 06800420 |
| 21 VA checker plate | 06800421 |

This operating manual contains descriptions of our products, but it does not give any warranties for specific properties or operational results. Authoritative is, unless otherwise specified, only the technical base, at the time of delivery of the goods in combination with this manual, by HEUTE Maschinenfabrik GmbH & Co. KG. The products and their design are subject to constant changes / improvements. We reserve the right to apply technical changes, anytime.

This manual is protected by copyrights. All rights reserved. This manual shall not be copied, translated, or otherwise modified, unless explicitly accepted, in writing, by the manufacturer (HEUTE Maschinenfabrik GmbH & Co. KG).



Höhscheider Weg 37 · 42699 Solingen · Germany
Phone: +49(0)212-380 310 · Fax: +49(0)212-380 31-49
E-mail: info@heute-gmbh.de · Internet: www.heute-gmbh.de